

SOHO

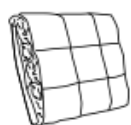

STRUTTURA VERO LEGNO
REAL WOOD STRUCTURE



SPALLIERA IN PIUMA
CON SUPPORTO IN
POLIURETANO ESPANSO
DENSITÀ 23 KG/M³
BACK CUSHION
IN FEATHER WITH
POLYURETHANE FOAM
SUPPORT DENSITY 23 KG/M³



CUSCINO SEDUTA IN
POLIURETANO ESPANSO
DENSITÀ 35 KG/M³
RIVESTITA IN CLIMASOFT
SITTING CUSHION:
POLYURETHANE FOAM
DENSITY 35 KG/M³
COVERED WITH CLIMASOFT

PELLE / LEATHER



SPALLIERA SFODERABILE
REMOVABLE UPHOLSTERY
FOR BACK CUSHIONS



CUSCINI DI SEDUTA SFODERABILI
REMOVABLE UPHOLSTERY
FOR SITTING CUSHIONS

TESSUTO / FABRIC

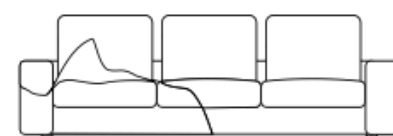

COMPLETAMENTE SFODERABILE
FULLY REMOVABLE COVERING

FINITURA PIEDE STANDARD
STANDARD FOOT FINISHING

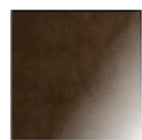

TITANIO LUCIDO
H. 16,5 cm

FINITURE OPTIONAL
OPTIONAL FOOT FINISHINGS



INOX LUCIDO

cad. € 47



INOX SATINATO

cad. € 47



CHAMPAGNE
SATINATO

cad. € 47



RAL
LUCIDO/OPACO

cad. € 47

FINITURE E/O PIEDI OPTIONAL NECESSITANO DI ULTERIORI DUE SETTIMANE DI PRODUZIONE
OPTIONAL FEET AND FINISHINGS NEED TWO ADDITIONAL WEEKS OF PRODUCTION TIME

SPALLIERE DISPONIBILI / OPTIONAL BACK CUSHIONS

SPECIFICARE SEMPRE IL TIPO DI SPALLIERA SCELTA INCLUSA NEL PREZZO
PLEASE SPECIFY THE BACK CUSHION CHOSEN WHEN PLACING THE ORDER

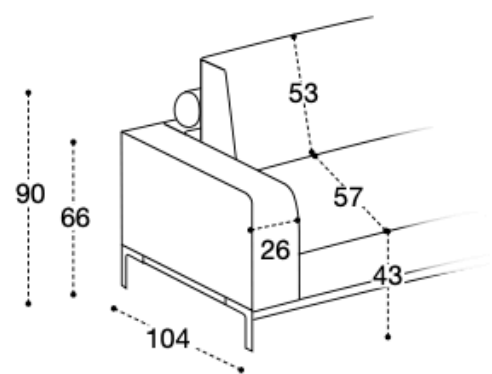

SPALLIERA PIUMA STANDARD
STANDARD FEATHER BACK CUSHION

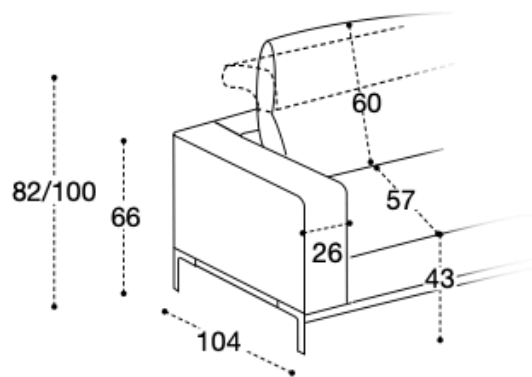

SPALLIERA PIUMA RECLINABILE
RECLINING FEATHER BACK CUSHION

ELEMENTO DIVISIBILE OPTIONAL
OPTIONAL DIVISIBLE ELEMENTS

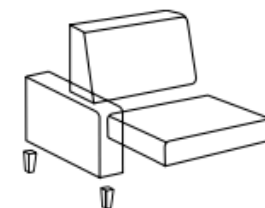

€ 120 ogni elemento

POSSIBILITÀ DI RICEVERE GLI ELEMENTI
DIVISI IN PIÙ PARTI ED IMBALLATI
SEPARATEMENTE, DA MONTARE
DIRETTAMENTE IN LOCO
POSSIBILITY TO RECEIVE THE ELEMENTS
DIVIDED INTO SEPARATE PARTS
AND PACKAGED SEPARATELY, TO BE
ASSEMBLED DIRECTLY ON SITE

VERSIONE IN TESSUTO: SU RICHIESTA È POSSIBILE AVERE LA BASE IN PELLE COMPRESA NEL PREZZO DEL TESSUTO
FABRIC VERSION: SOFA BASE STRUCTURE AVAILABLE IN LEATHER, INCLUDED IN STANDARD PRICE

DIVANO

SOFA

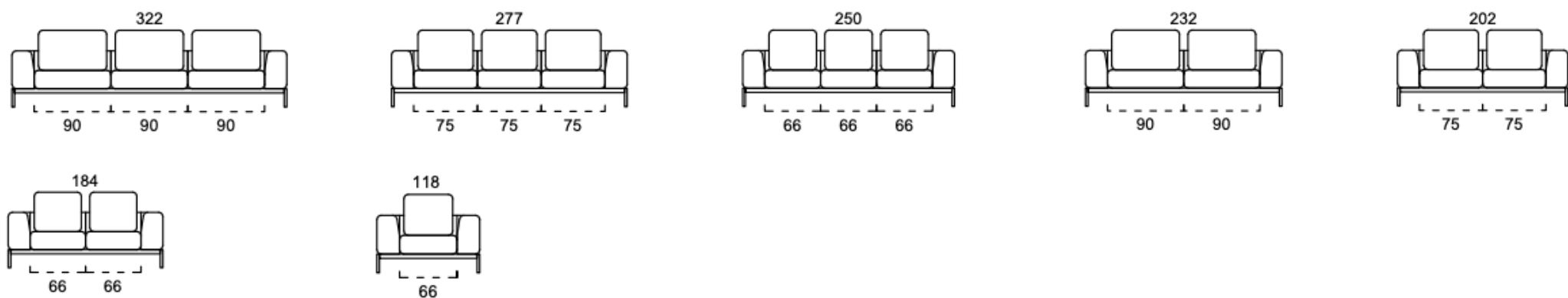

TERMINALE SX/DX

LHF/RHF SOFA

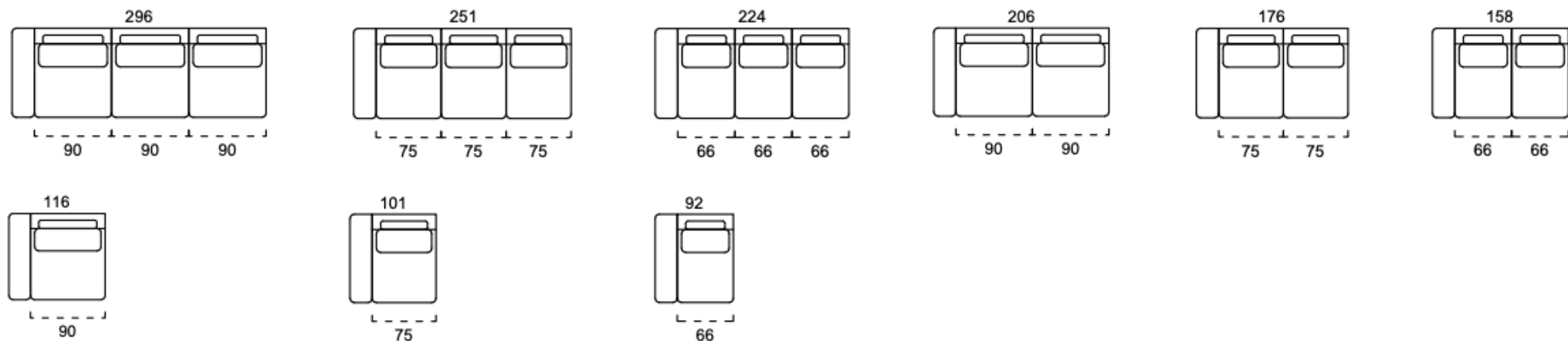

SCOCCA CENTRALE

CENTRAL ELEMENT

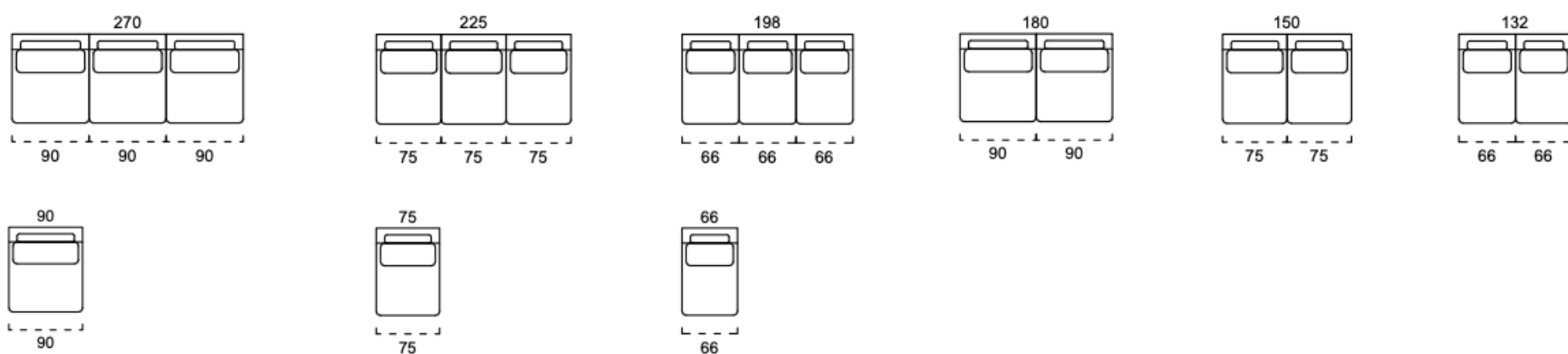

CHAISE LONGUE SX/DX

LHF/RHF CHAISE LONGUE

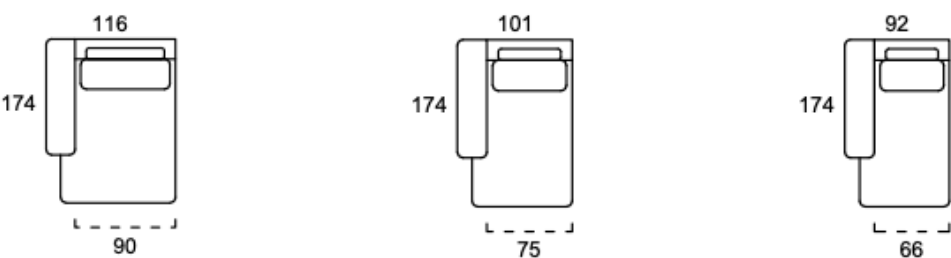

ELEMENTI SPECIALI SX/DX

LHF/RHF SPECIAL MODULES

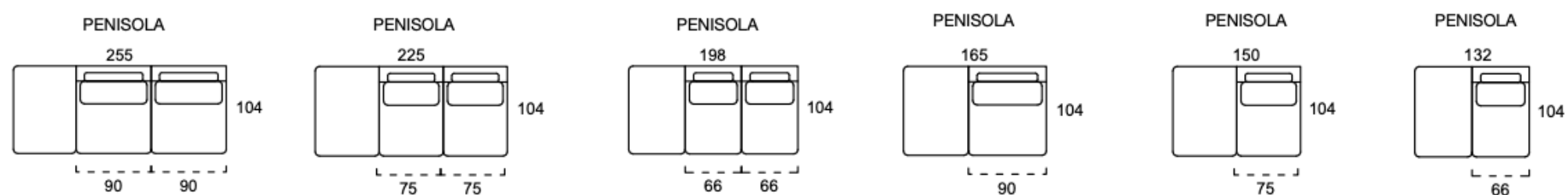

ANGOLO TERMINALE EXTRALARGE

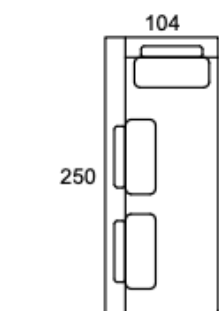

ANGOLO TERMINALE MAXI

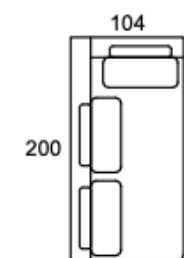

ANGOLO TERMINALE GRANDE

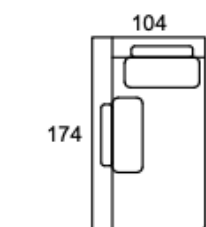

ANGOLO RETTO

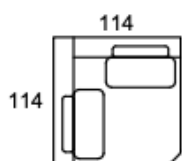

DORMEUSE

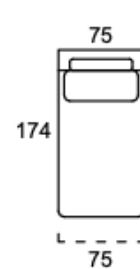

DORMEUSE

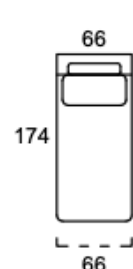

POUF

FOOTSTOOL

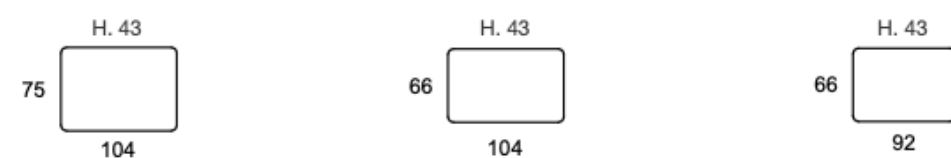

SX/DX SI INTENDE GUARDANDO L'ELEMENTO, I GRAFICI RAPPRESENTATI SONO SX
LEFT OR RIGHT HAND FACING, CHARTS SHOWN ABOVE ARE LHF